

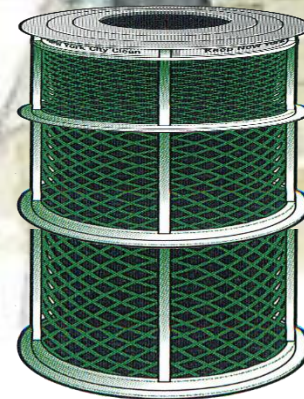

# NYC'S GARBAGE

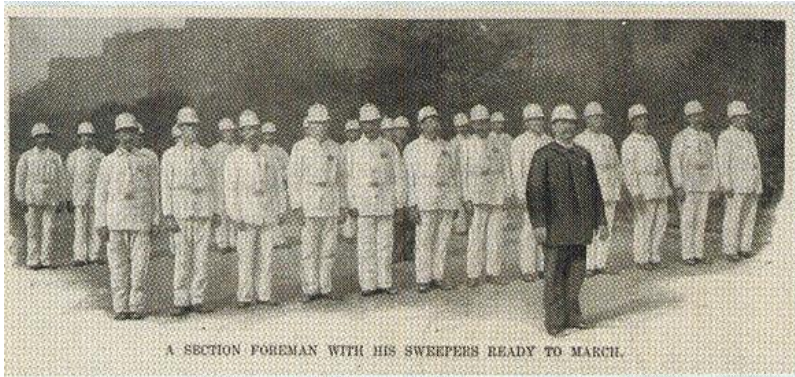

# HISTORY



Part of Waring's restructuring process included enforcing a strict dress code that required sanitation workers to wear all-white uniforms, which coined the nickname the "White Wings."

When Colonel George Waring was appointed to be the Commissioner of the Department of Street Cleaning in 1895, he molded the department into a quasi-military style structure that DSNY still uses today. Enabling it to effectively tackle the city's sanitation crisis and pervasive corruption.

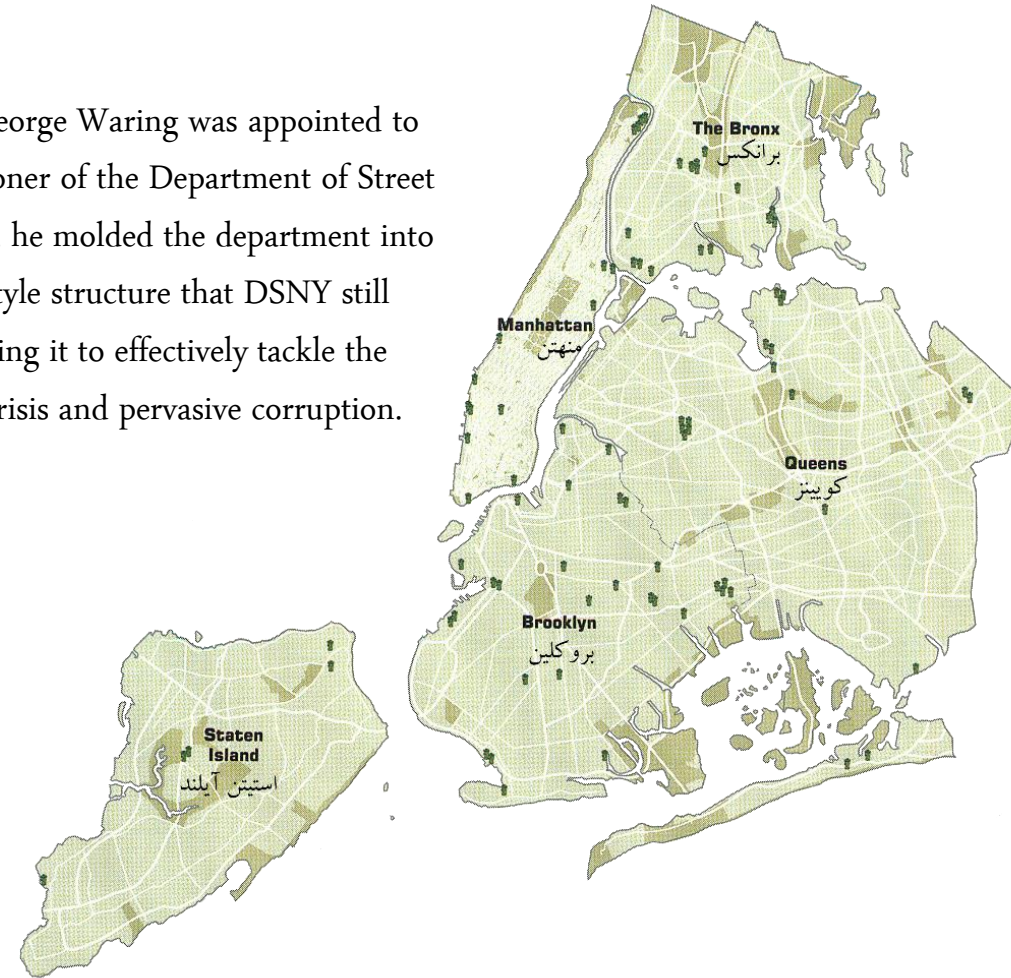



# The City of New York Department of Sanitation(DSNY)

[About](#)

[Services](#)

[Resources](#)

[Our Work](#)

[Contact](#)



TODAY

DEC  
13



Alternate Side  
Parking  
**IN EFFECT**



Collections  
**ON SCHEDULE**



Schools  
**OPEN**

Keeping NYC  
clean, safe, and healthy  
since 1881

# SNOW

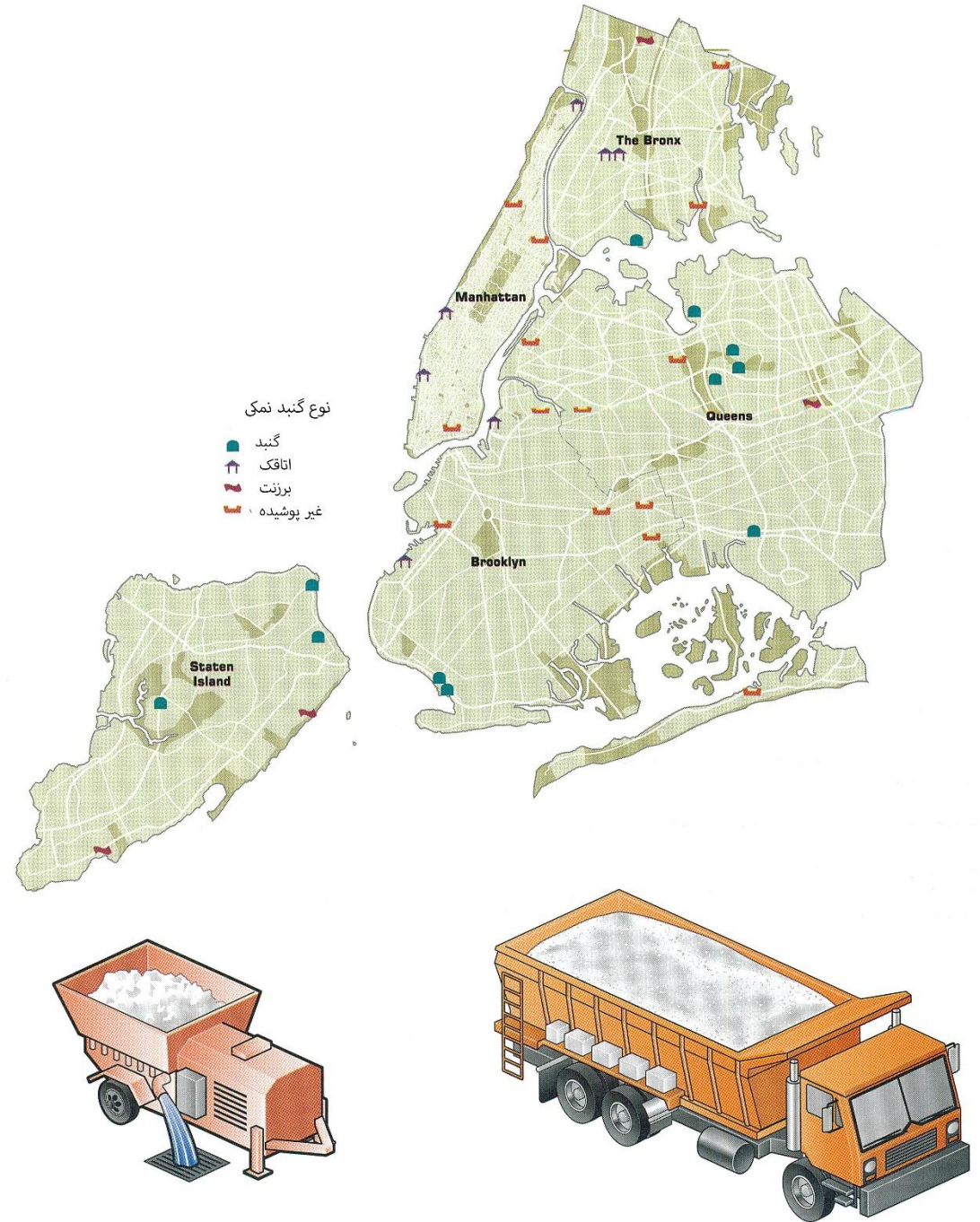
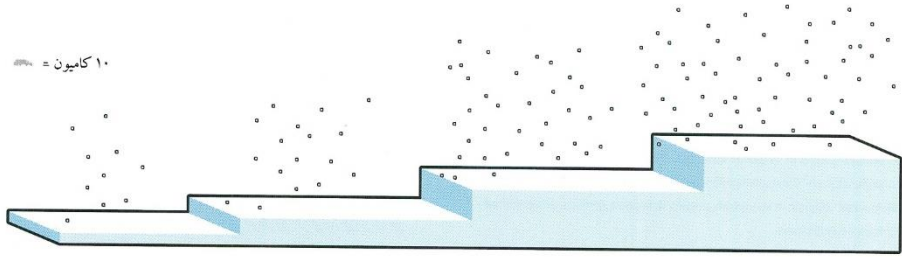

# CLEANING

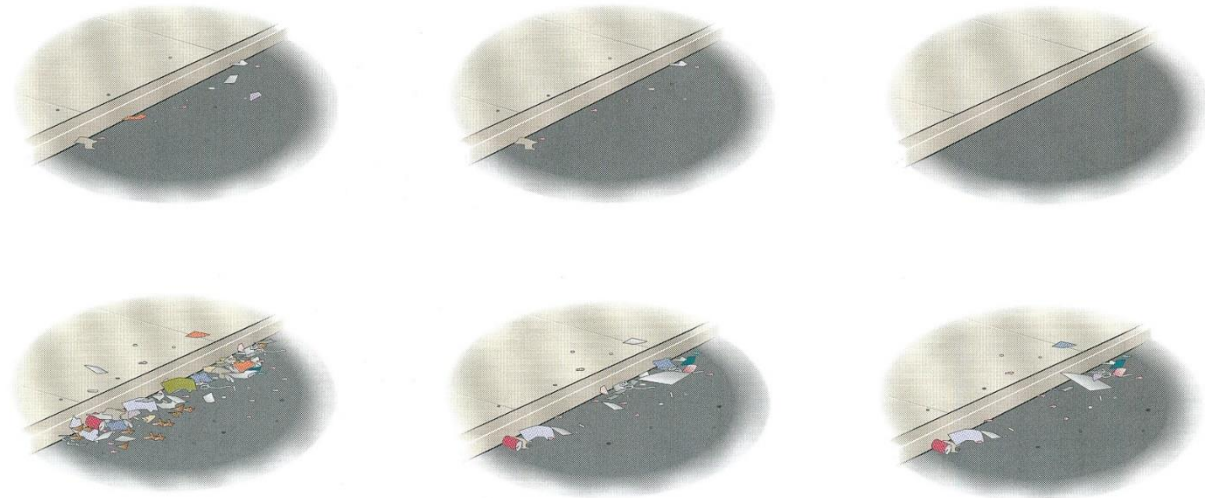
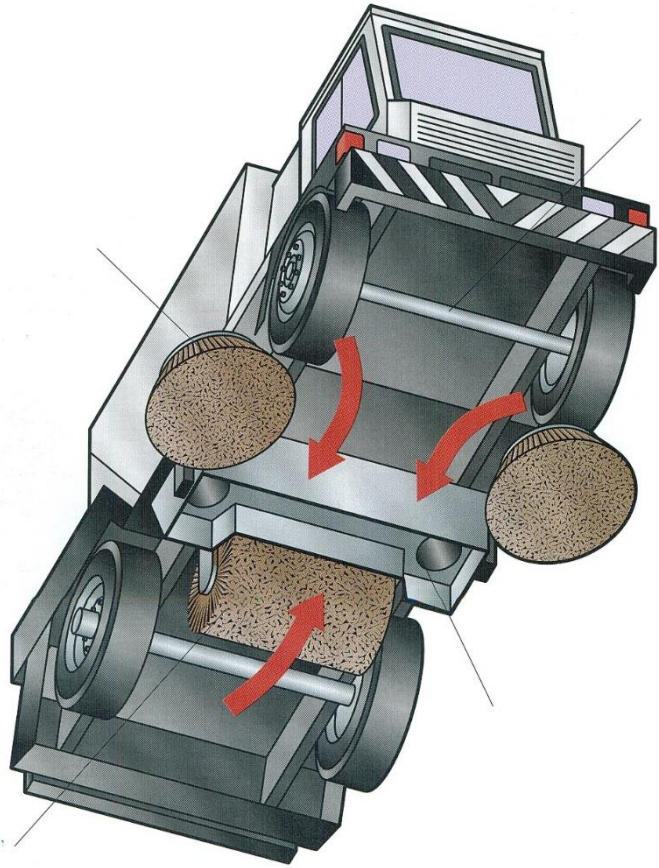

# COLLECTION

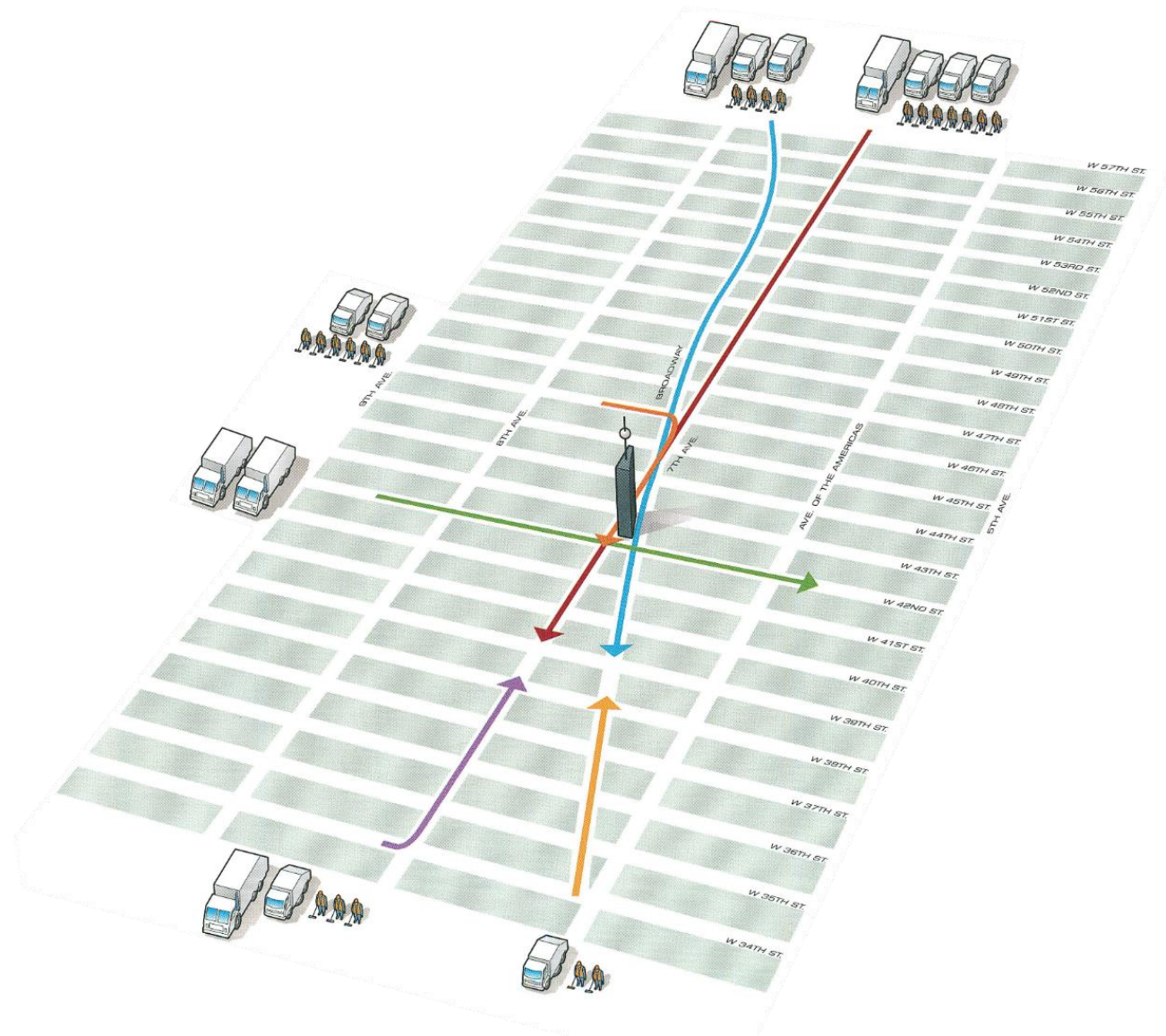
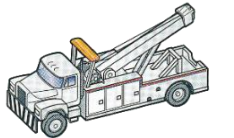

# ROOSEVELT ISLAND

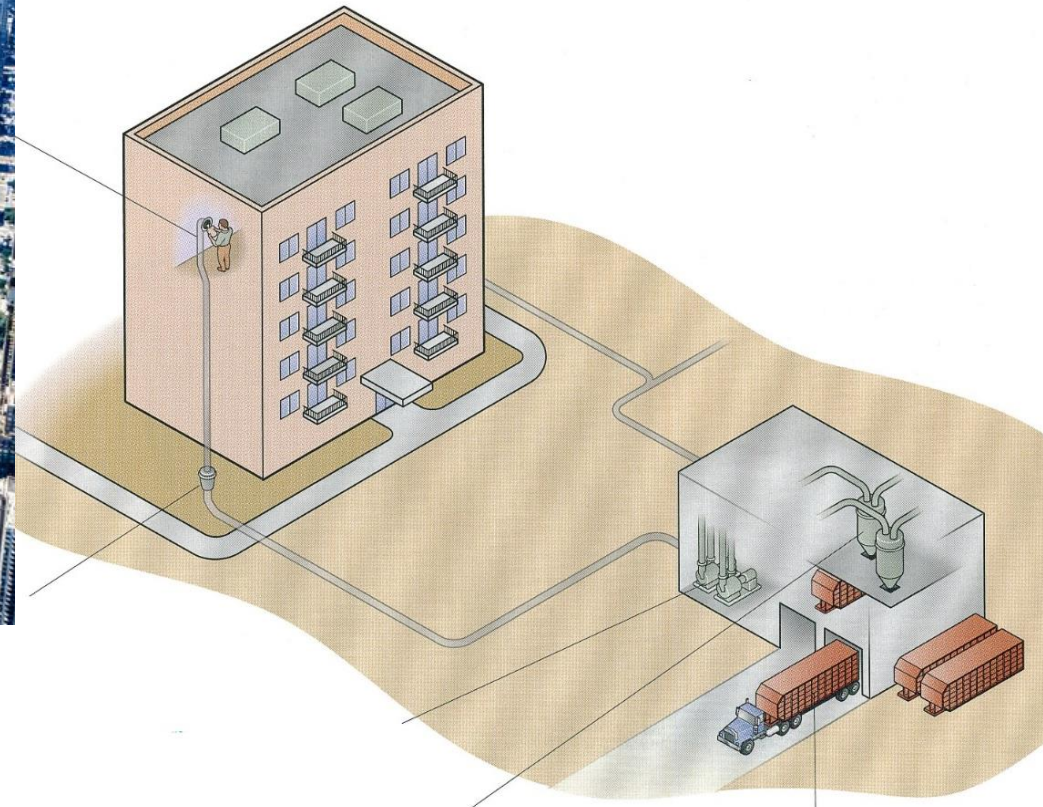

# RECYCLING

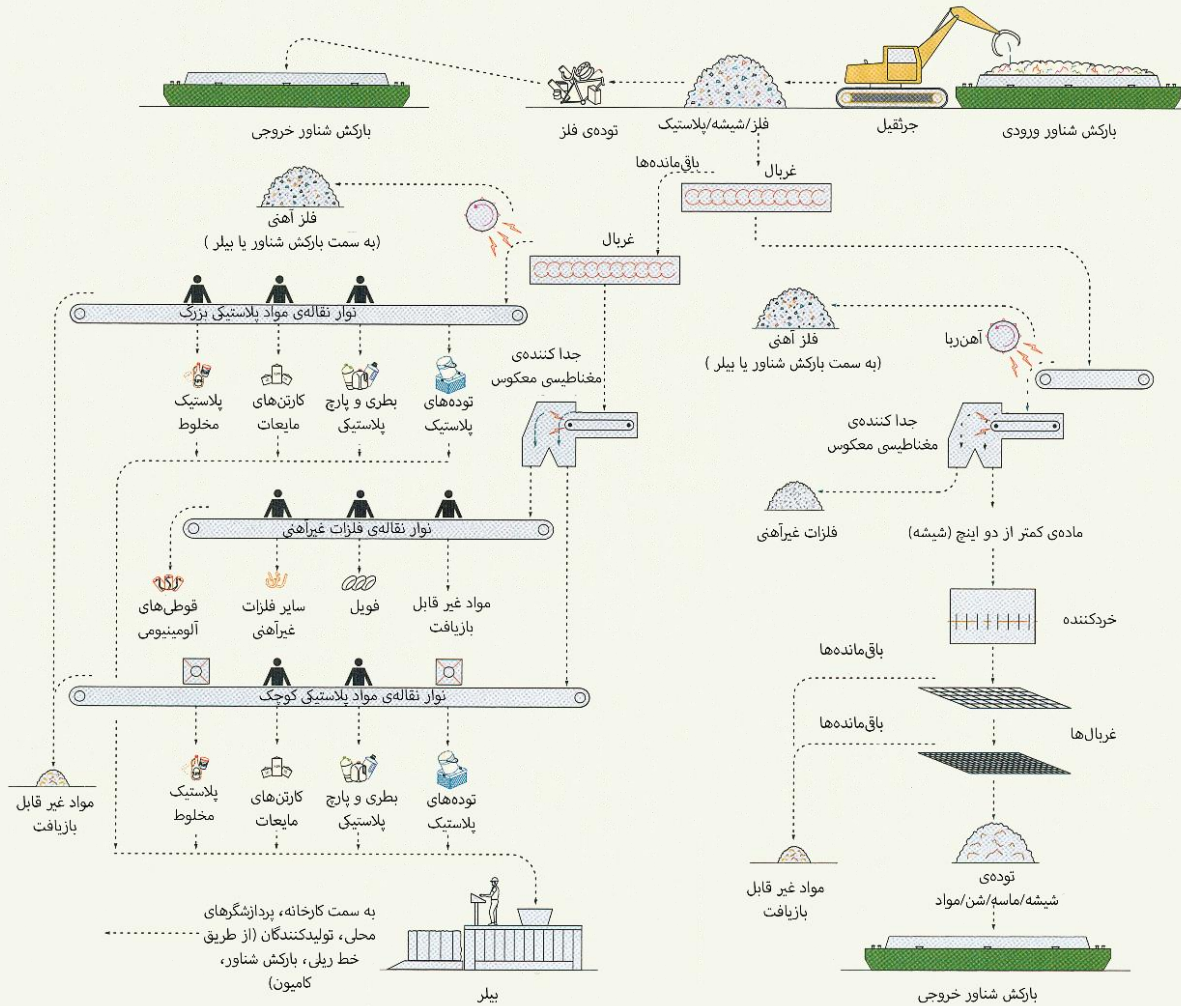

- مراکز پذیرش هوگو نوی
- مراکز پردازنده‌ی جدید در پارک سان ست
- مسیرهای فعلی بارکش‌های شناور
- مسیرهای آینده‌ی بارکش‌های شناور

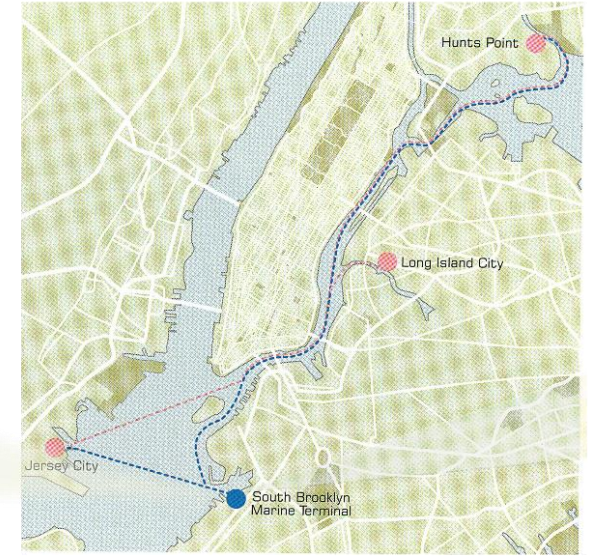

HUGO NEU



# PAPER

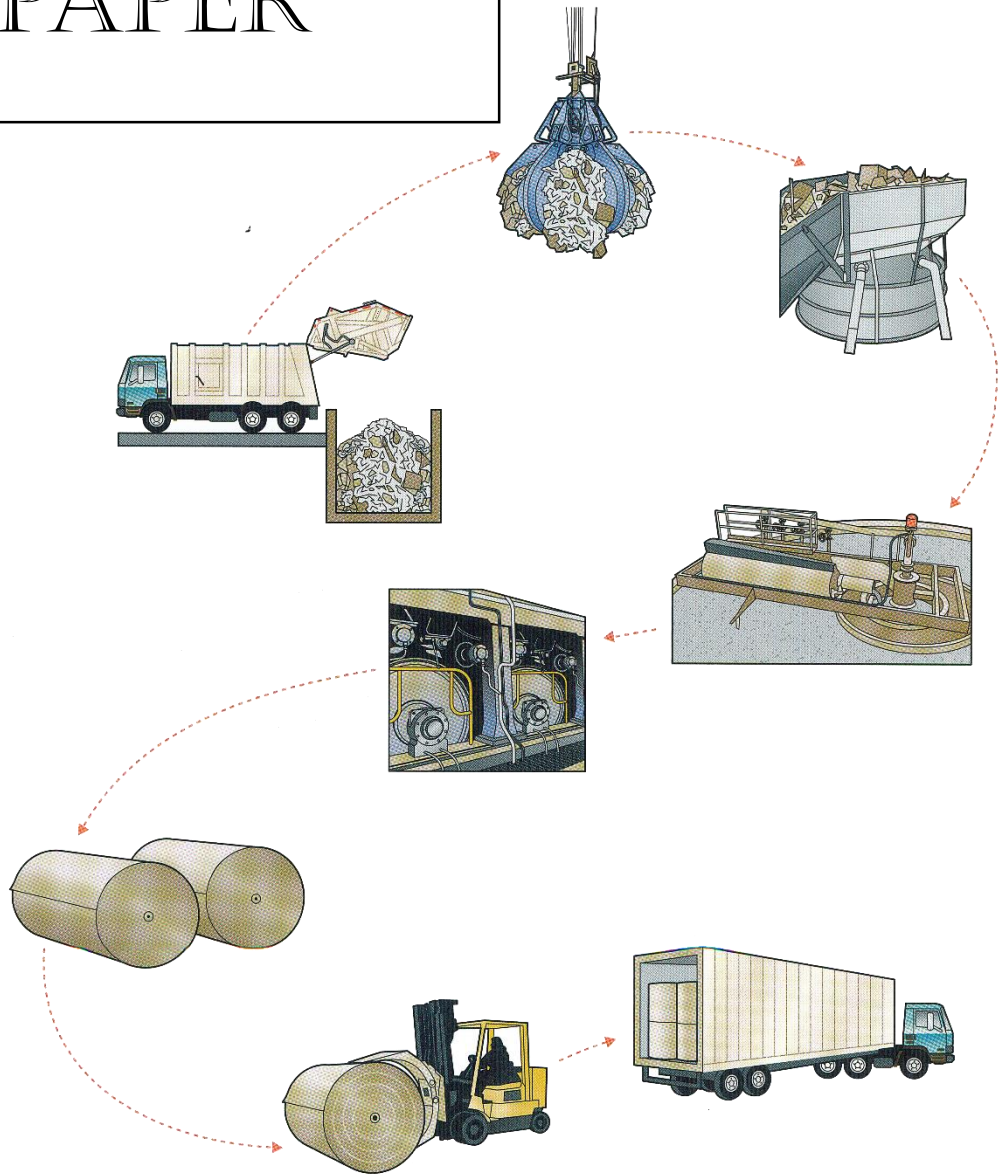

# COMPOSTING

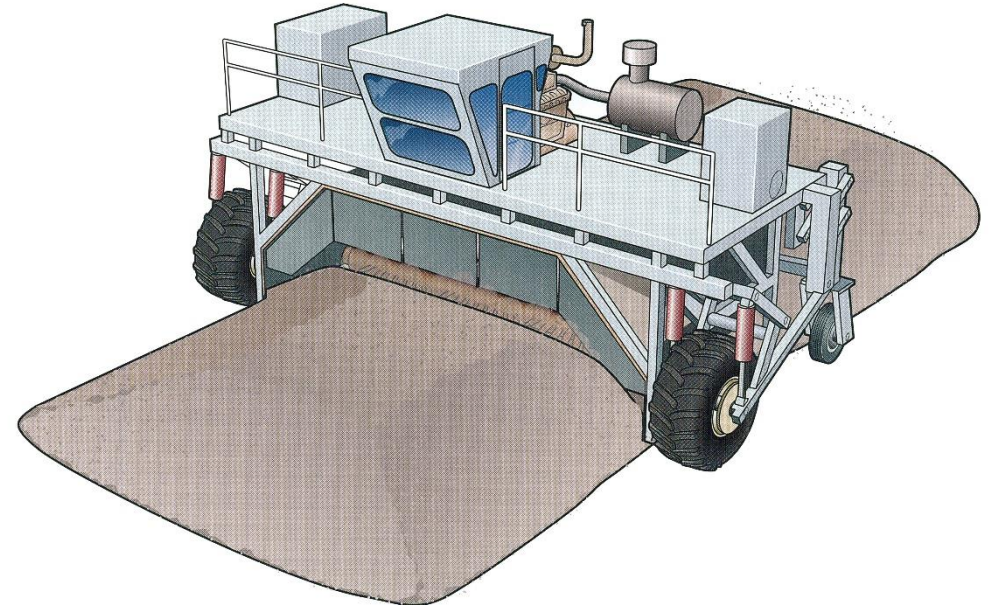

# RIKERS ISLAND



# THERE'S NO "AWAY"

FRESH KILLS  
LANDFILL

